

SPPL12420EVK Evaluation Kit User Manual

2 A Synchronous Rectified Step-Down Converter

FEATURES

- 2 A, 3.3 V output
- Wide input voltage range: 4.5 V to 24 V
- High full load and light load efficiency
- About 4 x 3 cm² reference layout w/o input filter (full board size is 7.2 x 6.5 cm²)
- Optional input filter
- Optional test point for current ripple measurements
- Signals accessible by pin connectors
- Power signals also accessible by pole terminals

APPLICATIONS

- High-Density Point-of-Load Regulators
- Distributed Power Systems
- Satellite Systems
- Launch Vehicles

BOARD PHOTO

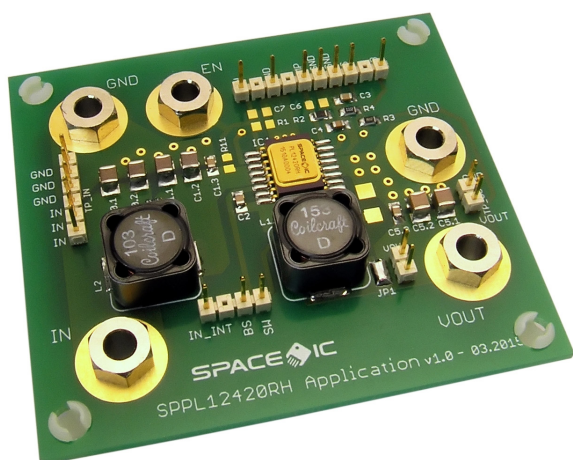

DESCRIPTION

The SPPL12420EVK is an evaluation board designed to demonstrate all of the features and performance of the SPPL12420RH.

The SPPL12420RH is a radiation hardened monolithic synchronous buck regulator featuring integrated 110 mΩ MOSFETs that provide continuous 2 A output load current. The board operates over a wide 4.5 V to 24 V input voltage range while providing 3.3 V fixed output voltage with very low output ripple and high efficiency. It features an optional EMC input filter (C10, L2) which can be bypassed.

The SPPL12420EVK is a compact 7.2 x 6.5 cm² double-sided PCB. The board features pin connectors and pole terminals for easy connection to instrumentation and / or system prototypes. Its compact reference layout may easily be integrated into the prototype layouts.

EFFICIENCY @ 3.3 V_{OUT}

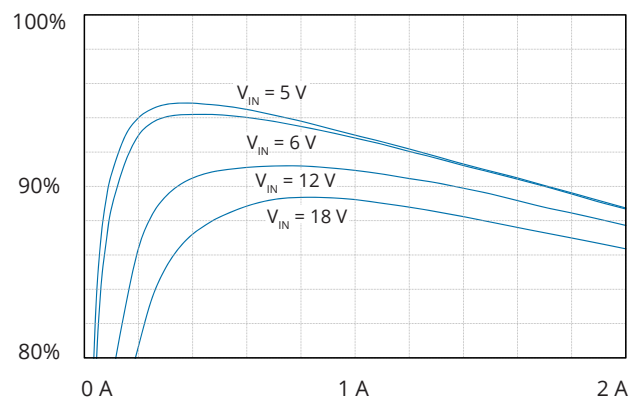

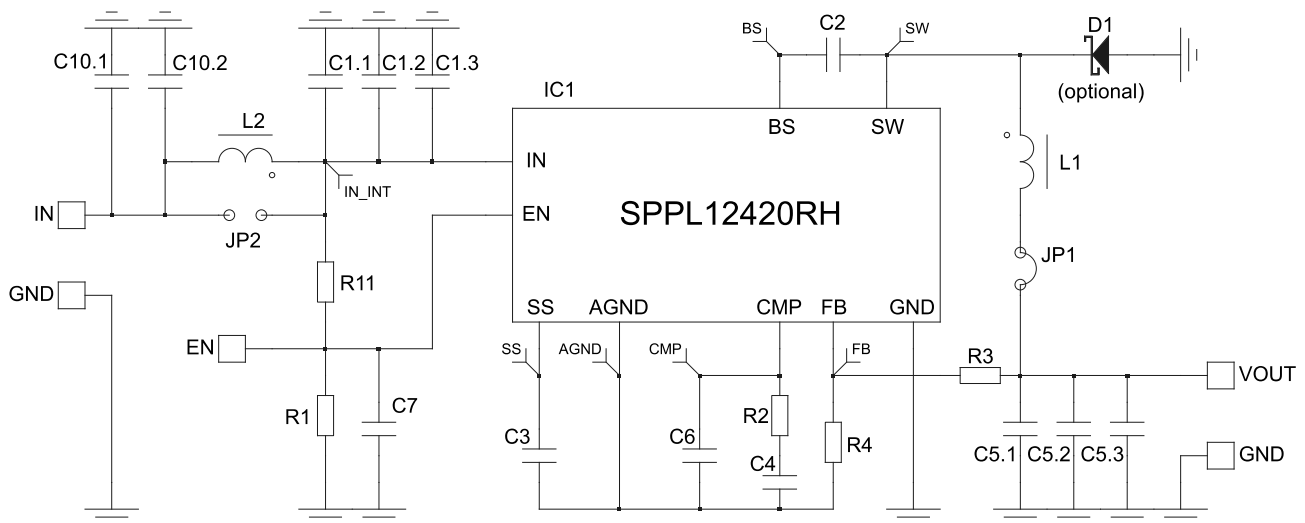
EVALUATION BOARD SCHEMATIC

BILL OF MATERIALS

REF	VALUE	DESCRIPTION	SIZE	MANUF.	PART NUMBER
C1.1/2	10 μ F	50V, X7R, 10%, ceramic capacitor	1210	Murata	GRM32ER71H106KA12L
C1.3	100 nF	50V, X7R, 10%, ceramic capacitor	0805	Multicomp	MCSH21B104K500CT
C2	10nF	50V, X7R, 10%, ceramic capacitor	0805	Multicomp	MCSH21B103K500CT
C3	100 nF	50V, X7R, 10%, ceramic capacitor	0805	Multicomp	MCSH21B104K500CT
C4	15nF	50V, X7R, 10%, ceramic capacitor	0805	Multicomp	MCSH21B153K500CT
C5.1/2	22 μ F	25V, X7R, 10%, ceramic capacitor	1210	Murata	GRM32ER71E226KE15L
C5.3	100 nF	50V, X7R, 10%, ceramic capacitor	0805	Multicomp	MCSH21B104K500C
C6/7	-	not installed	0805		
C10.1/2	10 μ F	50V, X7R, 10%, ceramic capacitor	1210	Murata	GRM32ER71H106KA12L
D1		30V, 1A, Schottky - not installed	SMA	Diodes Inc.	B130-13-F
L1	15 μ H	4.9A, 20%, power inductor	12x12mm ²	Coilcraft	MSS1278T-153MLD
L2	10 μ H	5.7A, 20%, power inductor	12x12mm ²	Coilcraft	MSS1278T-103MLD
R1/11	-	not installed	0805		
R2	4.7 k Ω	0.1W, 5%, thick film resistor	0805	Multicomp	MC01W080554K7
R3	26.1 k Ω	0.1W, 1%, thick film resistor	0805	Multicomp	MC01W0805126K1
R4	10 k Ω	0.1W, 1%, thick film resistor	0805	Multicomp	MC01W0805110K
IC1		2A Step Down Converter	FP-16	SPACE IC	SPPL12420RH-EM

EVALUATION BOARD LAYOUT

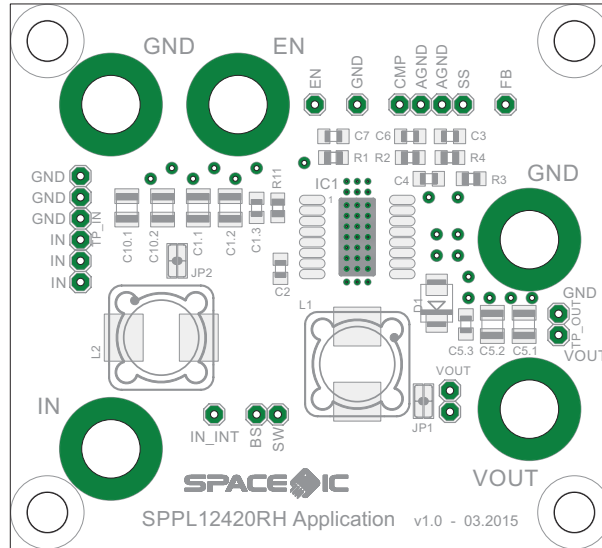

Figure 1. Top Placement

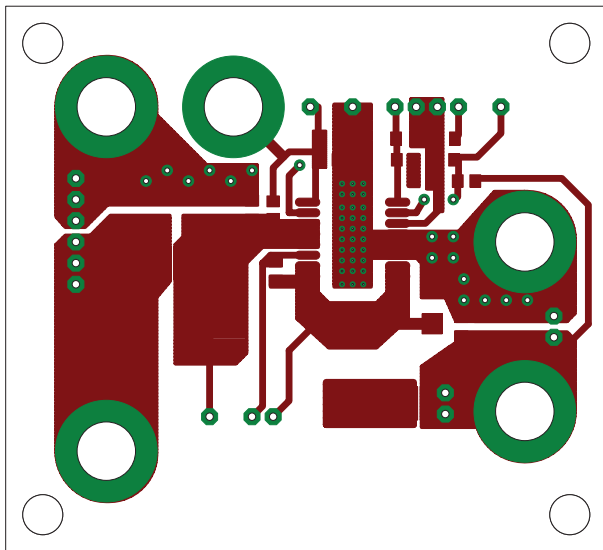

Figure 2. Top Copper Layer

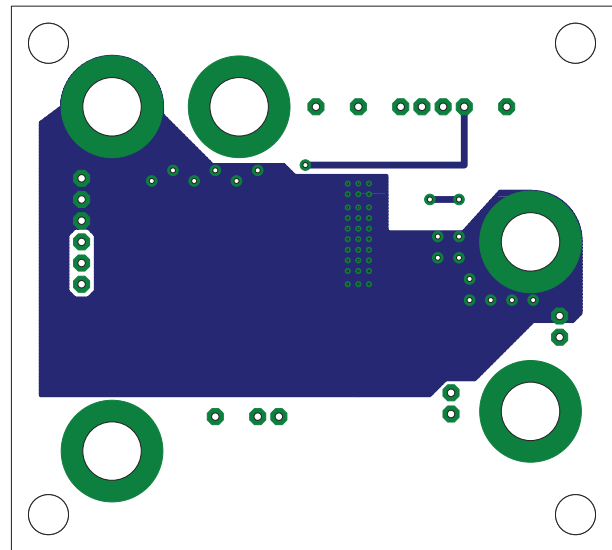

Figure 3. Bottom Copper Layer

QUICK START GUIDE

1. Connect load terminals to the VOUT and GND pins on the SPPL12420EVK. Keep the resistance of the connection wiring at very low levels to minimize any ohmic losses.
2. Connect the VIN and GND pins on the SPPL12420EVK to the external power supply. The recommended input voltage is between 4.5 V and 24 V. Applying a voltage that exceeds the absolute maximum rating of the SPPL12420RH IN pin (28 V) may damage the device. Note that the absolute maximum voltage rating of the EN pin is 6 V.
3. Use a voltmeter and / or an oscilloscope with voltage and current probes to check the operation of the SPPL12420RH.

TYPICAL PERFORMANCE

Figure 4 shows typical line and load regulation performance measured with an electronic load in constant resistance mode.

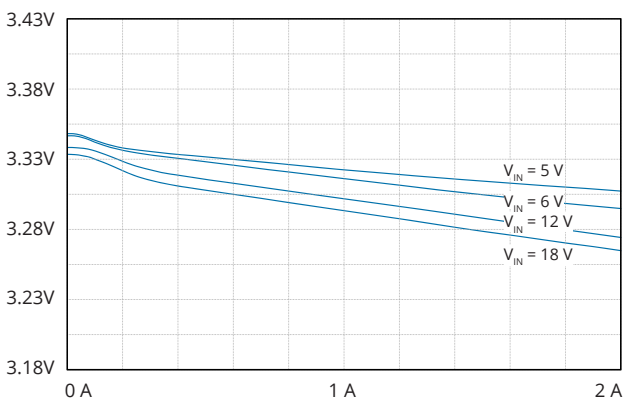

Figure 4. SPPL12420EVK Regulation Performance

SETTING THE OUTPUT VOLTAGE

The SPPL12420EVK output is preset to 3.3 V. However, it may easily be adjusted to other common values. By looking at the SPPL12420EVK schematic, the output voltage depends on the feedback voltage V_{FB} and the resistor divider network consisting of R_3 and R_4 , as expressed with the following equation:

$$V_{OUT} = V_{FB} \cdot \frac{R_3 + R_4}{R_4}$$

The R_4 resistor value may be as high as 100 k Ω , however 10 k Ω resistor value is typically recommended. Given this and the typical V_{FB} of 0.923 V, the R_3 resistor may easily be calculated for a desired output voltage. Table 1 exemplifies several standard resistor values needed to achieve desired output voltage. If standard resistor values are not available a parallel combination of two standard resistors may also be used.

V_{OUT} [V]	R_3 [k Ω]	R_4 [k Ω]
1.2	3.0	10
1.8	9.53	10
2.5	16.9	10
3.3	26.1	10
5	44.2	10
12	121	10

Table 1. Examples of R_3/R_4 for Typical Output Voltages

IMPORTANT NOTICE

The information contained in this document is believed to be accurate at the time of printing. SPACE IC reserves the right to make changes to its products or specifications without notice, however, and assumes no responsibility or liability for the use of its products; nor does the purchase, lease, or use of a product or service from SPACE IC convey a license under any patent rights, copyrights, trademark rights, or any other of the intellectual rights of SPACE IC or of third parties. Please visit our website for the most recent revision of this datasheet or contact info@space-ic.com. Customers are responsible for their products and applications using SPACE IC products.

Resale of SPACE IC products or services with statements different from or beyond the parameters stated by SPACE IC for that product or service voids all express and any implied warranties for the associated SPACE IC product or service. SPACE IC is not responsible or liable for any such statements.

© 2017 SPACE IC GmbH. All rights reserved. Information and data in this document are owned by SPACE IC and may not be edited, reproduced or redistributed in any way without written consent from SPACE IC.