

SPLVDS031RH

Quad LVDS Line Driver



FEATURES

- DC to 400 Mbps / 200 MHz low noise, low skew, low power operation
 - 300 ps (max) channel-to-channel skew
 - 250 ps (max) pulse skew
 - 23 mA (max) power supply current
- LVDS outputs conform to TIA/EIA-644-A standard
- Radiation hardness
 - TID > 50 krad (Si)
 - SEE (except SET): LET > 60 MeV / (mg / cm²)
 - SET: LET > 35 MeV / (mg / cm²)
- Latch-up immune due to dielectric isolation
- Hermetic dual in-line 16-lead flatpack package
- Screened according to ESCC
- For point-to-point applications
- Pin compatible with UT54LVDS031LV
- Extended temperature range: -55 °C to +125 °C

APPLICATIONS

- Data Communications
- SpaceWire Links
- Satellite Systems
- Launch Vehicles

PIN DIAGRAM

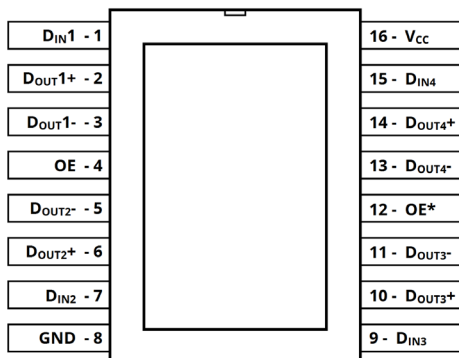

DESCRIPTION

The SPLVDS031RH is a radiation hardened 400 Mbps Quad LVDS (low voltage differential signaling) Line Driver optimized for high-speed, low power, low noise transmission over controlled impedance (approximately 100 Ω) transmission media (e.g. cables, printed circuit board traces, backplanes). The SPLVDS031RH accepts four LVCMOS / LVTTTL signals and translates them to four LVDS signals. Its differential outputs can be disabled and put in a high-impedance state via two enable pins, OE and OE*.

Low 300 ps (max) channel-channel skew and 250 ps (max) pulse skew ensure reliable communication in high-speed links that are highly sensitive to timing error. Supply current is 23 mA (max). LVDS outputs conform to the ANSI/ EIA/TIA-644-A standard. The SPLVDS031RH is offered in 16-lead flatpack package and operates over an extended -55 °C to +125 °C temperature range.

FUNCTION DIAGRAM

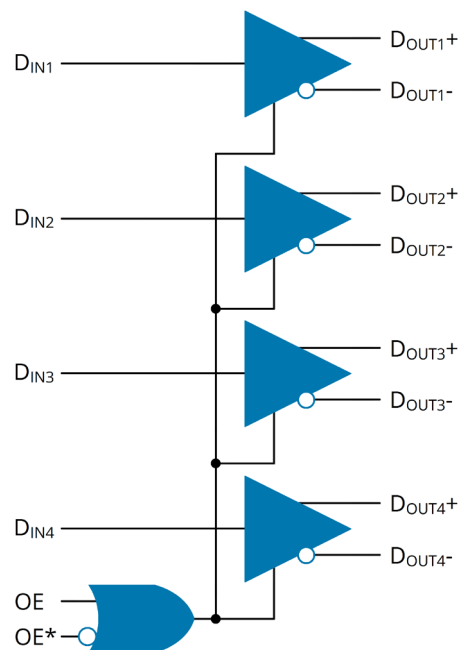

LOGIC TABLE

OE	OE*	D _{OUT} ⁺	D _{OUT} ⁻
0	0	Enabled	Enabled
0	1	Disabled	Disabled
1	0	Enabled	Enabled
1	1	Enabled	Enabled

PIN DESCRIPTIONS

PIN NAME	PIN NUMBER	PIN TYPE	PIN DESCRIPTION
D _{IN1} ['] , D _{IN2} ['] D _{IN3} ['] , D _{IN4} [']	1, 7, 9, 15	LVC MOS inputs	Driver LVC MOS input pins.
D _{OUT1} ⁺ , D _{OUT1} ⁻ , D _{OUT2} ⁺ , D _{OUT2} ⁻ , D _{OUT3} ⁺ , D _{OUT3} ⁻ , D _{OUT4} ⁺ , D _{OUT4} ⁻	2, 3, 5, 6, 10, 11, 13, 14	LVDS outputs	Non-inverting and inverting LVDS output pins.
OE, OE*	4, 12	LVC MOS inputs	Driver output enable pins. When OE is high or OE* is low or open, the driver outputs are enabled. When OE is low and OE* is high, the driver outputs are disabled.
VCC	16	Power	Power supply pin. Bypass Vcc to GND with 0.1 μF and 0.01 μF ceramic capacitors.
GND	8	Power	Ground or circuit common pin.

ABSOLUTE MAXIMUM RATINGS (NOTE1)

V_{CC} to GND.....	-0.3V to +4 V
Inputs	
OE, D_{IN} to GND	-0.3V to V_{CC} +0.3 V
Outputs	
D_{OUT+} , D_{OUT-} to GND.....	-0.3V to V_{CC} +0.3 V

16-Lead Flatpack Thermal Resistance (NOTE2)	
θ_{JC}	10 °C/W

T_J - Junction operating temperature	+150 °C
T_L - Lead temperature (soldering, 4 s).....	+260 °C
T_{stg} - Storage temperature range.....	-65 °C to +150 °C

ESD Ratings	
HBM ¹	8 kV
MM ²	250 V
CDM ³	1.25 kV

¹ Human Body Model, applicable standard JESD22-A114-C

² Machine Model, applicable standard JESD22-A 115-A

³ Field Induced Charge Device Model, applicable std. JESD22-C101-C

NOTE1 Stresses beyond those listed under “Absolute Maximum Ratings” may cause permanent damage to the device. These are stress ratings only, and functional operation of the device at these or any other conditions beyond those indicated in the operational sections of the specifications is not implied. Exposure to absolute maximum rating conditions for extended periods may affect device reliability.

NOTE2 When mounted on a standard JEDEC 2-layer FR-4 board.

RECOMMENDED OPERATING CONDITIONS

Symbol	Parameter	Pins	MIN	TYP	MAX	Unit
V_{CC}	Supply voltage	V_{CC}	3.0	3.3	3.6	V
V_{IH}	High-level input voltage	OE, OE*, D_{IN}	2.0		V_{CC}	V
V_{IL}	Low-level input voltage	OE, OE*, D_{IN}	0		0.8	V
T_A	Operating free-air-temperature	All	-55	25	125	°C

ELECTRICAL CHARACTERISTICS

Recommended operating conditions (NOTE3), $T_A = 25$ °C, $V_{CC} = 3.3V$, unless otherwise specified.

Symbol	Parameter	Conditions	MIN	TYP	MAX	Unit
LVCMOS Specifications (OE, OE*, D_{IN} pins)						
V_{IH}	High-level input voltage		2.0		V_{CC}	V
V_{IL}	Low-level input voltage		GND		0.8	V
I_H	High-level input current	$V_{CC} = 3.6$ V $V_{IN} = 3.6$ V	-10		10	µA
I_L	Low-level input current	$V_{CC} = 3.6$ V $V_{IN} = 0$ V	-10		10	µA
V_{CL}	Input clamp voltage (NOTE4)	$I_{CL} = -18$ mA, $V_{CC} = 0$ V	-1.5	-0.9		V

ELECTRICAL CHARACTERISTICS (CONTINUED)

Over recommended operating conditions (NOTE3), $T_A = 25\text{ }^\circ\text{C}$, $V_{CC} = 3.3\text{V}$, unless otherwise specified.

Symbol	Parameter	Conditions	MIN	TYP	MAX	Unit
LVDS Specifications (D_{OUT+}, D_{OUT-} pins)						
$ V_{OD} $	Differential output voltage magnitude	$R_L = 100\ \Omega$ Figure 1	250	370	450	mV
$ \Delta V_{OD} $	Change in magnitude of V_{DD} for complimentary output states		-35		35	mV
$V_{OCM(SS)}$	Steady-state output common mode voltage		1.125	1.25	1.375	V
$\Delta V_{OCM(SS)}$	Change in magnitude of $V_{OCM(SS)}$ for complimentary output states		-25		25	mV
V_{OH}	Output high voltage	$R_L = 100\ \Omega$ Figure 1		1.43	1.6	V
V_{OL}	Output low voltage		0.9	1.06		V
I_{OS}	Output short circuit current (NOTE5)	Enabled, D_{OUT+} or $D_{OUT-} = 0\text{ V}$			-13	mA
I_{OSD}	Differential output short circuit current (NOTE5)	Enabled, $V_{OD} = 0\text{ V}$			-13	mA
I_{OZ}	High-impedance output current	Disabled, $V_{OUT} = 0\text{ V}$ or V_{CC}	-14		+14	μA
C_{OUT}	Output capacitance (NOTE4)	D_{OUT+} or D_{OUT-} to GND		3		pF
Power Supply Current Specifications						
I_{CC}	Power supply current without output loads	Enabled, $D_{IN} = 0\text{ V}$ or V_{CC}		1	2	mA
I_{CCL}	Power supply current with output loads	Enabled, $D_{IN} = 0\text{ V}$ or V_{CC} , $R_L = 100\ \Omega$		16	23	mA
I_{CCZ}	Power supply current with disabled outputs	Disabled, $OE = 0$ and $OE^* = 1$		1	2	mA

NOTE3 Current into device pin is defined as positive. Current out of the device is defined as negative.

All voltages are referenced to ground, unless otherwise specified.

NOTE4 This specification is not production tested and is guaranteed by design simulations.

NOTE5 Output short circuit current (I_{OS}) is specified as magnitude only. The minus sign indicates direction only.

SWITCHING CHARACTERISTICS

 Over recommended operating conditions (NOTE3), $T_A = 25\text{ }^\circ\text{C}$, $V_{CC} = 3.3\text{V}$, unless otherwise specified.

Symbol	Parameter	Conditions	MIN	TYP	MAX	Unit	
LVDS AC Specifications (NOTES 6, 7)							
t_{PLH}	Propagation delay, low-to-high	$R_L = 100\ \Omega$ $C_L = 15\ \text{pF}$ (NOTE13) Figures 2 and 3	0.6	1	1.9	ns	
t_{PHL}	Propagation delay, high-to-low		0.6	1	1.9	ns	
t_r	Rise time			0.35	1	ns	
t_f	Fall time			0.35	1	ns	
$t_{SK(p)}$	Pulse skew (NOTE8)				50	250	ps
$t_{SK(c-c)}$	Channel-to-channel skew (NOTE9)				80	300	ps
$t_{SK(p-p)A}$	Part-to-part skew (NOTE10)					1	ns
$t_{SK(p-p)B}$	Part-to-part skew (NOTE11)					1.3	ns
t_{PLZ}	Disable time, low-to-high Z		$R_L = 100\ \Omega$ $C_L = 15\ \text{pF}$ (NOTE13) Figures 4 and 5			5	ns
t_{PHZ}	Disable time, high-to-high Z					5	ns
t_{PZL}	Enable time, high Z-to-low				5	ns	
t_{PZH}	Enable time, high Z-to-high				5	ns	
f_{MAX}	Maximum operating frequency (NOTE12)	Figure 2	200			MHz	

NOTE6 Generator output characteristics (unless otherwise specified): $f = 1\ \text{MHz}$, $Z_0 = 50\ \Omega$, $t_r < 1\ \text{ns}$, $t_f < 1\ \text{ns}$.

NOTE7 Switching Characteristic specification are not production tested and are guaranteed by statistical analysis of characterization data.

NOTE8 $t_{SK(p)}$ pulse skew, is the magnitude difference in propagation delay time between the positive going edge and the negative going edge of the same channel ($t_{SK(p)} = |t_{PLH} - t_{PHL}|$).

NOTE9 $t_{SK(c-c)}$ channel-to-channel skew, is the difference in propagation delay time between channels on the same device at any operating temperature and supply voltage.

NOTE10 $t_{SK(p-p)A}$ part-to-part skew "A", is the difference in propagation delay time between devices operating at the same power supply voltage and within $5\text{ }^\circ\text{C}$ of each other within the operating temperature range.

NOTE11 $t_{SK(p-p)B}$ part-to-part skew "B", is the difference in propagation delay time between devices operating at any recommended power supply voltage and ambient temperature. It is also defined as $|MIN - MAX|$ propagation delay (t_{PLH} or t_{PHL}).

NOTE12 Generator output characteristics for the f_{MAX} : $Z_0 = 50\ \Omega$, $t_r = t_f < 1\ \text{ns}$, 50% duty cycle, 0V to 3V amplitude. Output criteria for f_{MAX} : 45% / 55% duty cycle, $V_{OD} \geq 250\ \text{mV}$.

NOTE13 The capacitive load C_L includes test fixture, probe and lumped capacitance.

TEST CIRCUITS AND TIMING DIAGRAMS

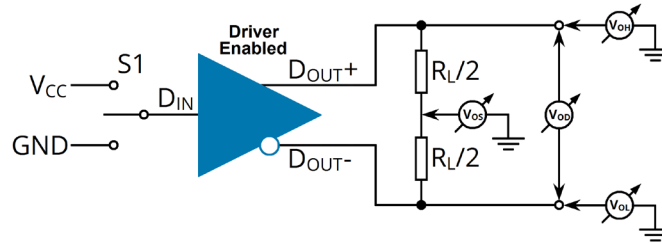

Figure 1. Driver V_{OH} and V_{OL} Test Setup

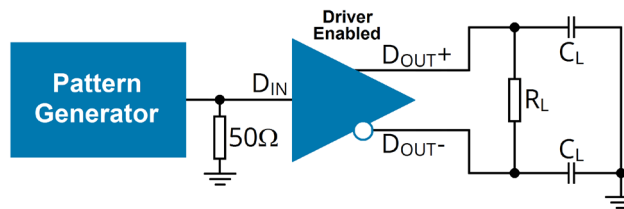

Figure 2. Driver Propagation Delay and Transition Time Test Setup

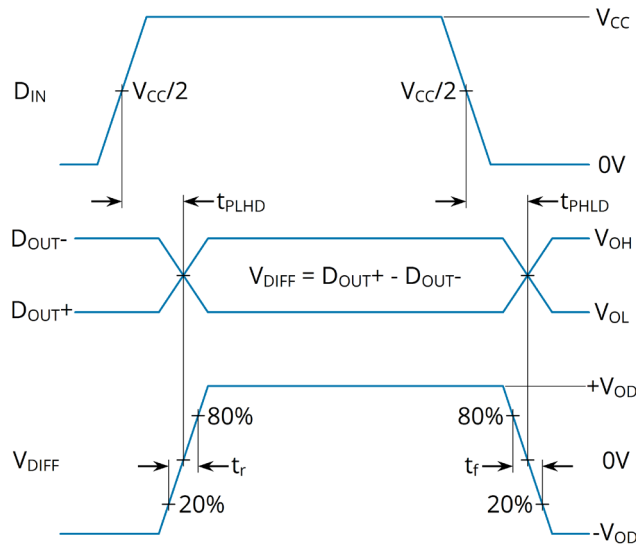

Figure 3. Driver Propagation Delay and Transition Time Waveforms

TEST CIRCUITS AND TIMING DIAGRAMS (CONTINUED)

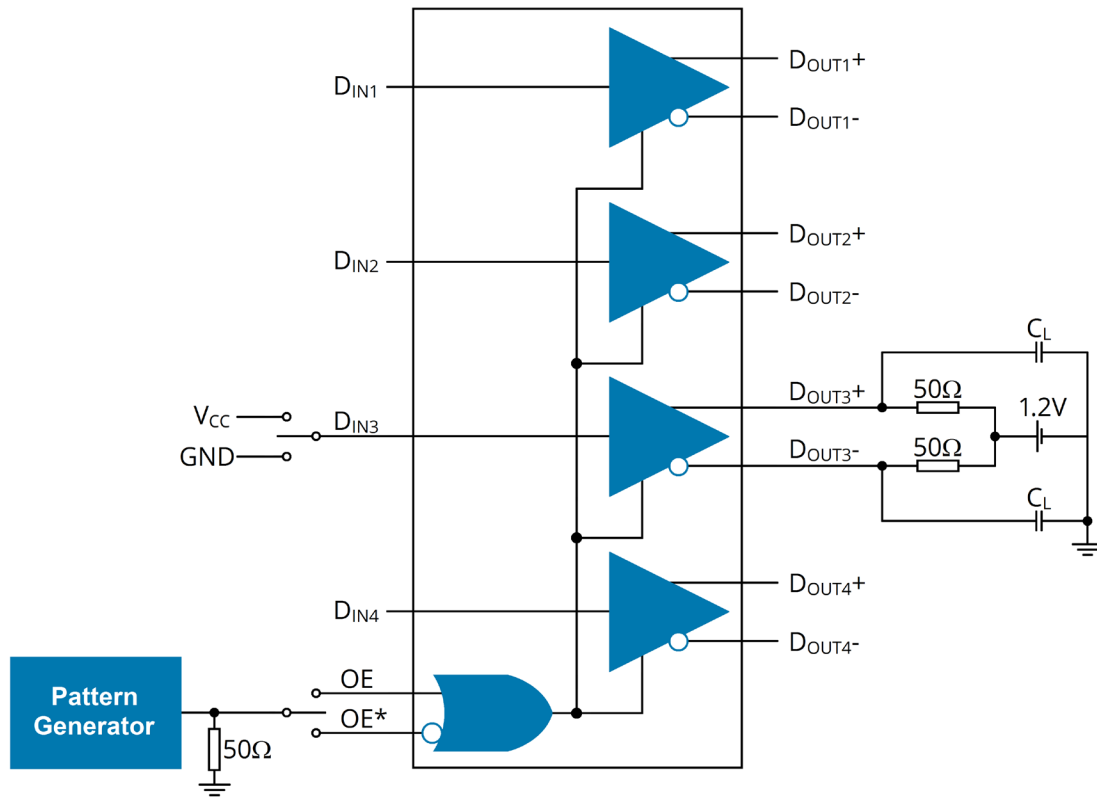

Figure 4. Driver High-Z Delay Test Setup

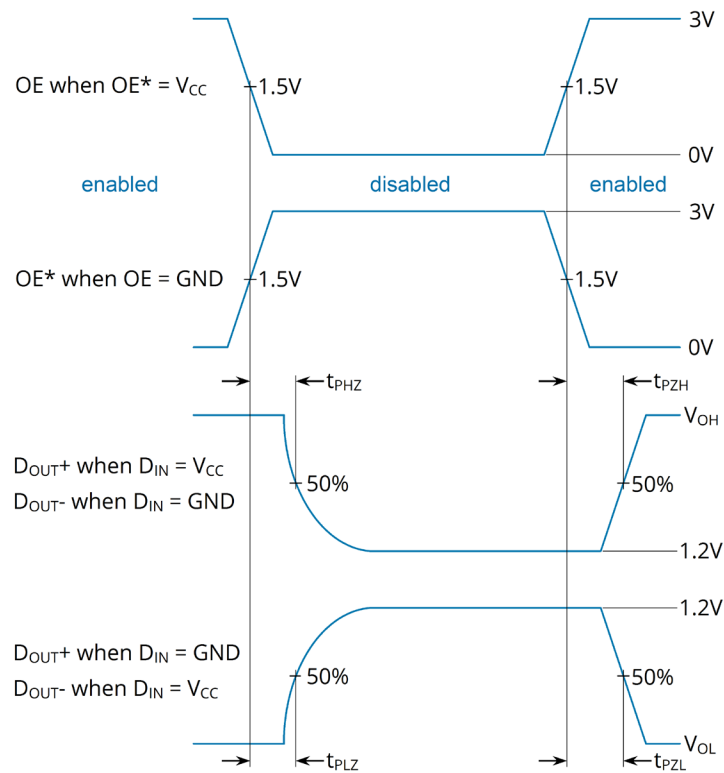

Figure 5. Driver High-Z Delay Waveforms

APPLICATION INFORMATION

ABOUT LVDS

Due to bandwidth and power consumption, high speed communication links usually use differential signaling. In this area LVDS provides an outstanding performance to power ratio: It offers a high bandwidth at very low power consumption and low EMI. Therefore it is used extensively for audio and video transmission, ASIC and FPGA I/O, sensor data transmission, clock distribution and a lot more signaling tasks.

COMMON MODE

Having a look at a transmission line, usually there will be two grounds, one transmitter ground potential and one receiver ground potential. Defined by standard LVDS specification, the receiver input signal has to be between 0 and 2.4 Volts. Taking into account the typically at 1.2 Volts centered LVDS signal with a standard 400 millivolt differential signal this results in a maximum ground shift or noise margin of plus/minus 1 Volt. This means that steady-state differences as well as momentary shifts have to be lower than 1 Volt in absolute value. Usually this is enough margin, but under noisy conditions, at long distances or inadequate ground connection this may cause data transfer errors.

GROUND BOUNCE AND GROUND DRIFT

Large switching currents in an electrical system may result in a momentary voltage drop in supply voltage and/or in a local raise of the ground potential. In terms of the instantaneous ground potential shift this behaviour is known as ground bounce. This reaction to high currents may be reduced by proper design and size of ground and supply planes and the use of low resistive decoupling capacitors, but they cannot be eliminated totally. Another effect in this context is a steady-state potential difference between ground connections: Each connection generates a voltage drop which follows Ohm's Law ($U = R * I$). As a result the ground potential difference between a module and the main ground plane rises linearly with current and terminal resistance. Since the terminal resistance may increase by aging, the ground potential of the connected module may drift more and more resulting in a higher steady-state potential difference. In both situations, ground bounce and ground drift, the common mode difference between transmitter and receiver may exceed the specified +/- 1 Volt defined by the LVDS standard resulting in communication errors or even link interruption. These effects have already been reported in Avionics, Industrial applications, by telecommunication companies and automobile manufacturers.

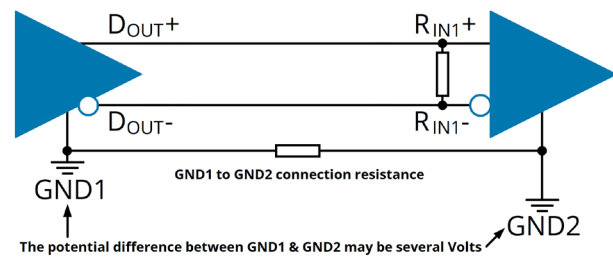

Figure 6. GND-potential difference

POSSIBLE SOLUTION: AC COUPLING?

One possibility to eliminate common mode differences caused by ground potential issues is the use of coupling capacitors on both channels of the differential pair. But there is a big constraint: Capacitive coupling is only convenient for DC balanced data. This means that the data has to have an equal number of ones and zeros. But generally this is not the case for non-coded data, audio, video, sensor or control signals. And if the data would be coded in order to get a balanced signal, this would have an impact on the bandwidth. In case of 8b/10b coding the net data rate will decrease by 20%.

RS-485

In noisy environments and applications with known common mode issues usually the RS-485/422 is used due to its large swing differential standard which guarantees communication at common modes of -7 to +12 Volts. Its disadvantages are the low data rate and the poor bandwidth to power and EMI performance.

SPLVDS: COMBINING THE ADVANTAGES

Having a look at the LVDS standard, the noise margin may be sufficient on single PCBs or in small boxed systems. But in noisy environments or larger distributed systems or box-to-box communication, the small +/-1 V common mode window potentially leads to communication problems, particularly over the lifetime of the system. RS-485 offers a much better noise margin but shows very poor performance regarding power consumption, speed and EMI. The new Space IC SPLVDS series combines the benefits of LVDS and RS-485: It's fully compatible with the LVDS standard in terms of signal levels, speed, power and EMI, showing the same pinout and footprint as competitor devices. Additionally it provides an extended common mode of -7 to +12 Volt what finally makes it a perfect choice for harsh environments. Also it works as a high-performance replacement for RS-485 applications.

PACKAGE DIMENSION (16-LEAD FLATPACK)

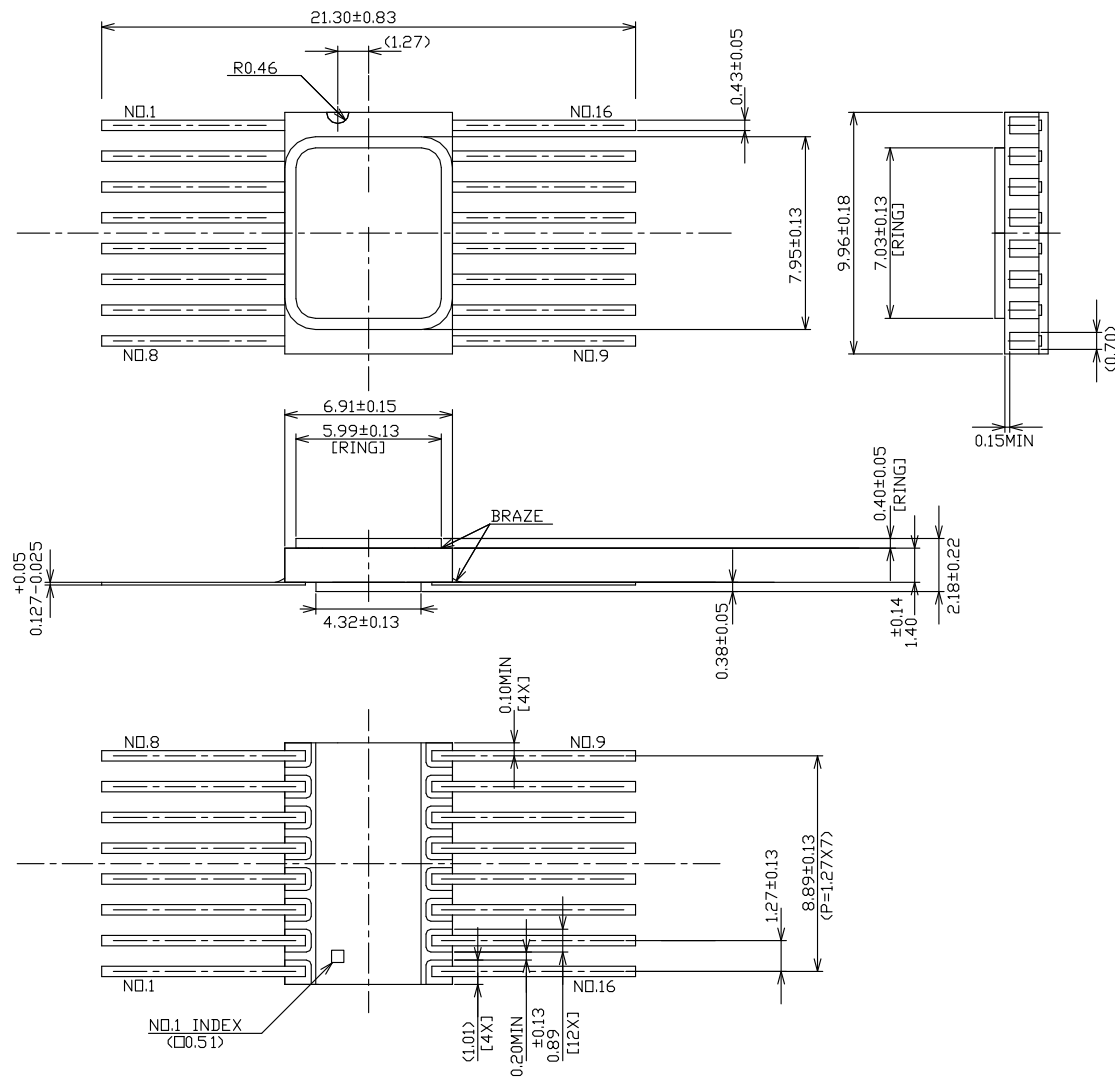

IMPORTANT NOTICE

The information contained in this document is believed to be accurate at the time of printing. SPACE IC reserves the right to make changes to its products or specifications without notice, however, and assumes no responsibility or liability for the use of its products; nor does the purchase, lease, or use of a product or service from SPACE IC convey a license under any patent rights, copyrights, trademark rights, or any other of the intellectual rights of SPACE IC or of third parties. Please visit our website for the most recent revision of this datasheet or contact info@space-ic.com. Customers are responsible for their products and applications using SPACE IC products.

Resale of SPACE IC products or services with statements different from or beyond the parameters stated by SPACE IC for that product or service voids all express and any implied warranties for the associated SPACE IC product or service. SPACE IC is not responsible or liable for any such statements.

© 2020 SPACE IC GmbH. All rights reserved. Information and data in this document are owned by SPACE IC and may not be edited, reproduced or redistributed in any way without written consent from SPACE IC.